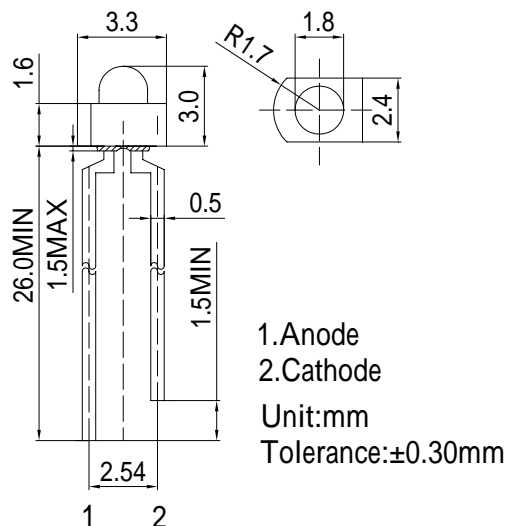

Features

- High Luminous LEDs
- 1.8mm Tower Standard Directivity
- Long Lifetime Operation (Up to 100,000 hours)
- Superior Weather-resistance
- UV Resistant Epoxy
- Water Clear Type

Applications

- Electronic Signs And Signals
- Small Area Illuminations
- Back Lighting
- Other Lighting

Outline Dimension

Absolute Maximum Rating (Ta=25 °C)

Item	Symbol	Value	Unit
DC Forward Current	I_F	30	mA
Pulse Forward Current*	I_{FP}	100	mA
Reverse Voltage	V_R	5	V
Power Dissipation	P_D	108	mW
Operating Temperature	T_{opr}	-30 ~ +85	
Storage Temperature	T_{stg}	-40 ~ +100	
Lead Soldering Temperature	T_{sol}	260 /5sec	-

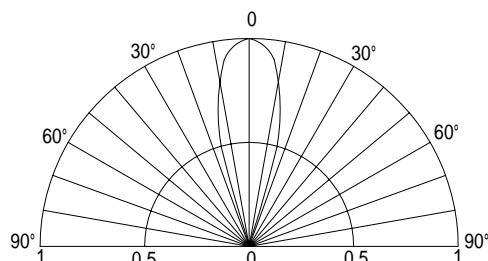
*Pulse width Max 10ms , Duty ratio max 1/10

Directivity

Electrical -Optical Characteristics (Ta=25 °C)

Item	Symbol	Condition	Min.	Typ.	Max.	Unit
DC Forward Voltage	V_F	$I_F=20mA$	2.9	3.1	3.6	V
DC Reverse Current	I_R	$V_R=5V$	-	-	10	μA
Luminous Intensity*	I_v	$I_F=20mA$	2180	3000	-	mcd
Chromaticity Coordinates*	x	$I_F=20mA$	-	0.45	-	
	y	$I_F=20mA$	-	0.41	-	
50% Power Angle	$2\theta_{1/2}$	$I_F=20mA$	-	30	-	deg

*1 Tolerance of chromaticity coordinates is ±10%

*2 Tolerance of luminous intensity is ±15%